

Dell™ Inspiron™ 1300/B120/B130 Service Manual

[Before You Begin](#)

[Hinge](#)

[System Components](#)

[Battery](#)

[Memory, Optical Drive, and Mini PCI Card](#)

[Hard Drive](#)

[Keyboard](#)

[Display Assembly](#)

[Palm Rest](#)

[Modem](#)

[Coin-Cell Battery](#)

[Microprocessor Thermal-Cooling Assembly](#)

[Microprocessor Module](#)

[Speakers](#)

[System Board](#)

[Antenna](#)

[Fan](#)



[Flashing the BIOS](#)

[Base Plastics](#)

[Pinout Assignments for I/O Connectors](#)

Model PP21L

Notes, Notices, and Cautions

-  **NOTE:** A NOTE indicates important information that helps you make better use of your computer.
 -  **NOTICE:** A NOTICE indicates either potential damage to hardware or loss of data and tells you how to avoid the problem.
 -  **CAUTION:** A CAUTION indicates a potential for property damage, personal injury, or death.
-

Information in this document is subject to change without notice.
© 2005 Dell Inc. All rights reserved.

Reproduction in any manner whatsoever without the written permission of Dell Inc. is strictly forbidden.

Trademarks used in this text: *Dell*, the *DELL* logo, and *Inspiron* are trademarks of Dell Inc.

Other trademarks and trade names may be used in this document to refer to either the entities claiming the marks and names or their products. Dell Inc. disclaims any proprietary interest in trademarks and trade names other than its own.

Antenna

Dell™ Inspiron™ 1300/B120/B130 Service Manual

● [Replacing the Antenna](#)

Replacing the Antenna

⚠ CAUTION: Before performing the following procedures, read the safety instructions in the *Product Information Guide*.

⚠ CAUTION: To prevent static damage to components inside your computer, discharge static electricity from your body before you touch any of your computer's electronic components. You can do so by touching an unpainted metal surface.

1. Follow the instructions in [Before Working Inside Your Computer](#).
2. Remove the hard drive. See [Removing the Hard Drive](#).
3. Remove the optical drive. See [Removing the Optical Drive](#).
4. Remove the memory module. See [Removing the Memory Module](#).
5. Remove the Mini PCI card. See [Removing the Mini PCI Card](#).
6. Remove the microprocessor thermal-cooling assembly. See [Removing the Microprocessor Thermal-Cooling Assembly](#).
7. Remove the microprocessor. See [Removing the Microprocessor Module](#).
8. Remove the hinge cover. See [Removing the Hinge Cover](#).
9. Remove the keyboard. See [Removing the Keyboard](#).
10. Remove the display assembly. See [Removing the Display Assembly](#).
11. Remove the palm rest. See [Removing the Palm Rest](#).
12. Remove the modem. See [Removing the Modem](#).
13. Remove the speakers connector. See [Removing the Speakers](#).
14. Remove the system board. See [Removing the System Board](#).
15. Remove the antenna cable from the guides.
16. Replace the antenna cable, securing it under the guides.

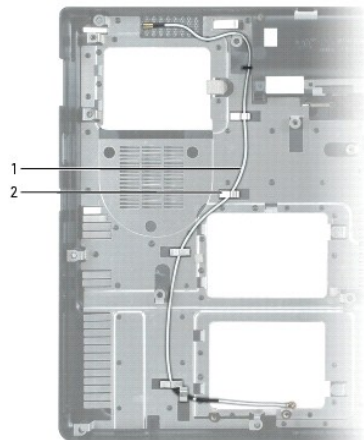



1	antenna cable	2	guides		
---	---------------	---	--------	--	--

[Back to Contents Page](#)

Base Plastics

Dell™ Inspiron™ 1300/B120/B130 Service Manual

 **CAUTION:** Before performing the following procedures, read the safety instructions in the *Product Information Guide*.

 **CAUTION:** To prevent static damage to components inside your computer, discharge static electricity from your body before you touch any of your computer's electronic components. You can do so by touching an unpainted metal surface.

1. Follow the instructions in [Before Working Inside Your Computer](#).
 2. Remove the hard drive. See [Removing the Hard Drive](#).
 3. Remove the optical drive. See [Removing the Optical Drive](#).
 4. Remove the memory module. See [Removing the Memory Module](#).
 5. Remove the Mini PCI card. See [Removing the Mini PCI Card](#).
 6. Remove the microprocessor thermal-cooling assembly. See [Removing the Microprocessor Thermal-Cooling Assembly](#).
 7. Remove the microprocessor. See [Removing the Microprocessor Module](#).
 8. Remove the hinge cover. See [Removing the Hinge Cover](#).
 9. Remove the keyboard. See [Removing the Keyboard](#).
 10. Remove the display assembly. See [Removing the Display Assembly](#).
 11. Remove the palm rest. See [Removing the Palm Rest](#).
 12. Remove the modem. See [Removing the Modem](#).
 13. Remove the speakers connector. See [Removing the Speakers](#).
 14. Remove the system board. See [Removing the System Board](#).
-

Battery

Dell™ Inspiron™ 1300/B120/B130 Service Manual

● [Replacing the Battery](#)

Replacing the Battery

⚠ CAUTION: Before performing these procedures, disconnect the modem from the telephone wall jack.

⚠ CAUTION: Using an incompatible battery may increase the risk of fire or explosion. Replace the battery only with a compatible battery purchased from Dell. The battery is designed to work with your Dell™ computer. Do not use a battery from other computers with your computer.

To remove the battery:

1. If the computer is connected to a docking device (docked), undock it. See the documentation that came with your docking device for instructions.
2. Ensure that the computer is turned off.
3. Turn over the computer.
4. Slide the battery-bay latch release lock on the bottom of the computer away from the battery.
5. Slide and hold the battery-bay latch release, and then remove the battery from the bay.

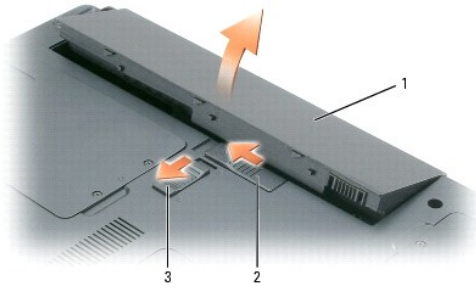

1	battery	2	battery-bay latch release	3	battery-bay latch release lock
---	---------	---	---------------------------	---	--------------------------------

To replace the battery, follow the removal procedure in reverse order.

Before You Begin

Dell™ Inspiron™ 1300/B120/B130 Service Manual

- [Recommended Tools](#)
- [Turning Off Your Computer](#)
- [Before Working Inside Your Computer](#)
- [Computer Orientation](#)
- [Screw Identification](#)

This chapter provides procedures for removing and installing the components in your computer. Unless otherwise noted, each procedure assumes that the following conditions exist:

- 1 You have performed the steps in [Turning Off Your Computer](#) and [Before Working Inside Your Computer](#).
 - 1 You have read the safety information in the *Product Information Guide*.
 - 1 A component can be replaced by performing the removal procedure in reverse order.
-

Recommended Tools

The procedures in this document may require the following tools:

- 1 Small flat-blade screwdriver
 - 1 Phillips screwdriver
 - 1 Small plastic scribe
 - 1 Hex nut driver
 - 1 Flash BIOS-update program floppy disk or CD
-

Turning Off Your Computer

➡ **NOTICE:** To avoid losing data, save and close any open files and exit any open programs before you turn off your computer.

1. Shut down the operating system:
 - a. Save and close any open files, exit any open programs, click the **Start** button, and then click **Turn Off Computer**.
 - b. In the **Turn off computer** window, click **Turn off**.

The computer turns off after the operating system shutdown process finishes.

2. Ensure that the computer and any attached devices are turned off. If your computer and attached devices do not automatically turn off when you shut down your operating system, press and hold the power button for 4 seconds.
-

Before Working Inside Your Computer

Use the following safety guidelines to help protect your computer from potential damage and to help ensure your own personal safety.

⚠ **CAUTION:** Before you begin any of the procedures in this section, follow the safety instructions in the *Product Information Guide*.

⚠ **CAUTION:** Handle components and cards with care. Do not touch the components or contacts on a card. Hold a card by its edges or by its metal mounting bracket. Hold a component such as a processor by its edges, not by its pins.

➡ **NOTICE:** Only a certified service technician should perform repairs on your computer. Damage due to servicing that is not authorized by Dell is not covered by your warranty.

➡ **NOTICE:** When you disconnect a cable, pull on its connector or on its strain-relief loop, not on the cable itself. Some cables have a connector with locking tabs; if you are disconnecting this type of cable, press in on the locking tabs before you disconnect the cable. As you pull connectors apart, keep them evenly aligned to avoid bending any connector pins. Also, before you connect a cable, ensure that both connectors are correctly oriented and aligned.

➡ **NOTICE:** To avoid damaging the computer, perform the following steps before you begin working inside the computer.

1. Ensure that the work surface is flat and clean to prevent the computer cover from being scratched.
2. Turn off your computer. See [Turning Off Your Computer](#).

➔ **NOTICE:** To disconnect a network cable, first unplug the cable from your computer and then unplug it from the network wall jack.

3. Disconnect any telephone, network, and USB cables from the computer.
4. Disconnect your computer and all attached devices from their electrical outlets.
5. Turn over the computer.

➔ **NOTICE:** To avoid damaging the system board, you must remove the main battery before you service the computer.

6. Remove the battery.
 - a. Slide the battery-bay latch release lock on the bottom of the computer away from the battery.
 - b. Slide and hold the battery-bay latch release, and then remove the battery from the bay.

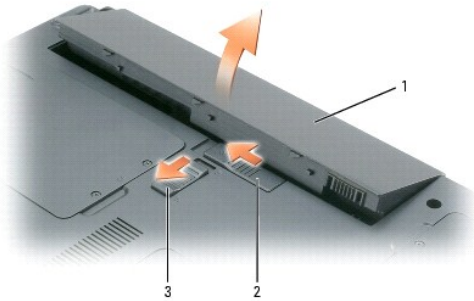

1	battery	2	battery-bay latch release	3	battery-bay latch release lock
---	---------	---	---------------------------	---	--------------------------------

7. Press the power button to ground the system board.
8. Remove any installed ExpressCards from the ExpressCard slot.

Computer Orientation

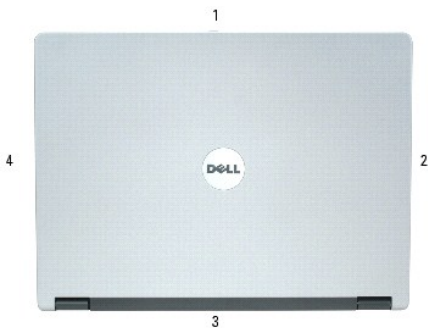

1	front	2	left	3	back	4	right
---	-------	---	------	---	------	---	-------

Screw Identification

When you are removing and replacing components, print this section as a tool to lay out and keep track of the screws. The printout provides the number of screws and their sizes.



M2 x 3 mm



M3 x 3 mm



M2.5 x 4 mm















M2.5 x 5 mm



M2.5 x 6 mm



M2.5 x 8 mm

<p>Optical Drive: (1 each)</p>  <p><i>M2.5 x 8 mm</i></p>	<p>Fan Module: (4 each)</p>  <p><i>M2.5 x 5 mm</i></p>	<p>Display Assembly to Computer Base: (4 each)</p>  <p><i>M2.5 x 8 mm</i></p>
<p>Modem to System Board: (2 each)</p>  <p><i>M2 x 3 mm</i></p>	<p>Display Bezel: (6 each)</p>  <p><i>M2.5 x 5 mm</i></p>	<p>Display Panel: (8 each)</p>  <p><i>M2 x 3 mm</i></p>
<p>Top of Palm Rest to Computer Base: (5 each of M2.5 x 5 mm) (2 each of M2 x 3 mm)</p>   <p><i>M2.5 x 5 mm</i> <i>M2 x 3 mm</i></p>	<p>Base Plastic to Palm Rest From Bottom: (10 each)</p>  <p><i>M2.5 x 8 mm</i></p>	<p>Hard Drive Carrier to Hard Drive: (2 each)</p>  <p><i>M3 x 3 mm</i></p>
<p>Speakers to Base Plastics: (1 for left speaker, 2 for right speaker, 3 total)</p>  <p><i>M2 x 3 mm</i></p>	<p>System Board to Base Plastics: (5 each, system board)</p>  <p><i>M2.5 x 5 mm</i></p>	<p>Keyboard to Palm Rest: (2 each)</p>  <p><i>M2.5 x 5 mm</i></p>

Flashing the BIOS

Dell™ Inspiron™ 1300/B120/B130 Service Manual

- [Flashing the BIOS From a CD](#)
- [Flashing the BIOS From the Hard Drive](#)

If a BIOS-update program CD is provided with the new system board, flash the BIOS from the CD. If you do not have a BIOS-update program CD, flash the BIOS from the hard drive.

Flashing the BIOS From a CD

1. Ensure that the AC adapter is plugged in and that the main battery is installed properly.

 **NOTE:** If you use a BIOS-update program CD to flash the BIOS, set up the computer to boot from a CD before inserting the CD.

2. Insert the BIOS-update program CD, and restart the computer.

Follow the instructions that appear on the screen. The computer continues to boot and updates the new BIOS. When the flash update is complete, the computer will automatically reboot.

3. Press <F2> during POST to enter the system setup program.
 4. Press <Alt> and <F> to reset the computer defaults.
 5. Press <Esc>, select **Save changes and reboot**, and press <Enter> to save configuration changes.
 6. Remove the flash BIOS-update program CD from the drive and restart the computer.
-

Flashing the BIOS From the Hard Drive

1. Ensure that the AC adapter is plugged in, the main battery is properly installed, and a network cable is attached.
 2. Turn on the computer.
 3. Locate the latest BIOS update file for your computer at support.dell.com.
 4. Click **Download Now** to download the file.
 5. If the **Export Compliance Disclaimer** window appears, click **Yes, I Accept this Agreement**.
The **File Download** window appears.
 6. Click **Save this program to disk** and then click **OK**.
The **Save In** window appears.
 7. Click the down arrow to view the **Save In** menu, select **Desktop**, and then click **Save**.
The file downloads to your desktop.
 8. Click **Close** if the **Download Complete** window appears.
The file icon appears on your desktop and is titled the same as the downloaded BIOS update file.
 9. Double-click the file icon on the desktop and follow the instructions on the screen.
-

Coin-Cell Battery

Dell™ Inspiron™ 1300/B120/B130 Service Manual

- [Removing the Coin-Cell Battery](#)
 - [Replacing the Coin-Cell Battery](#)
-

Removing the Coin-Cell Battery

- ⚠ **CAUTION:** Before performing the following procedures, read the safety instructions in the *Product Information Guide*.
- ⚠ **CAUTION:** To prevent static damage to components inside your computer, discharge static electricity from your body before you touch any of your computer's electronic components. You can do so by touching an unpainted metal surface.

1. Follow the instructions in [Before Working Inside Your Computer](#).
2. Remove the hinge cover. See [Removing the Hinge Cover](#).
3. Remove the keyboard. See [Removing the Keyboard](#).
4. Locate the coin-cell battery and disconnect the cable from the system board connector by pulling toward the coin-cell battery.
5. Remove the cable from the guides and lift the coin-cell battery from the computer.



Replacing the Coin-Cell Battery

1. Connect the cable to the system board by pushing it into the connector.
2. Route the cable through the channel and press the coin-cell battery into place.

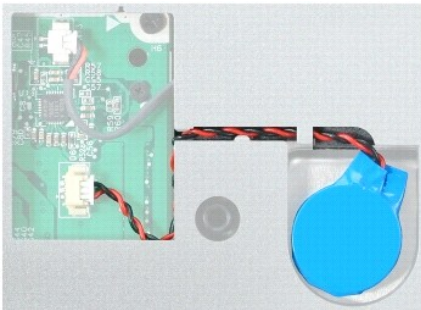

[Back to Contents Page](#)

Microprocessor Module

Dell™ Inspiron™ 1300/B120/B130 Service Manual

- [Removing the Microprocessor Module](#)
- [Installing the Microprocessor Module](#)

Removing the Microprocessor Module

⚠ CAUTION: Before performing the following procedures, read the safety instructions in the *Product Information Guide*.

⚠ CAUTION: To prevent static damage to components inside your computer, discharge static electricity from your body before you touch any of your computer's electronic components. You can do so by touching an unpainted metal surface.

- ➡ **NOTICE:** Press and hold the microprocessor down by applying slight pressure to the center of the microprocessor while turning the cam screw to prevent intermittent contact between the cam screw and microprocessor.
- ➡ **NOTICE:** To avoid damage to the microprocessor, hold the screwdriver so that it is perpendicular to the microprocessor when turning the cam screw.

1. Follow the instructions in [Before Working Inside Your Computer](#).

2. Turn over the computer.

3. Remove the microprocessor thermal-cooling assembly. See [Removing the Microprocessor Thermal-Cooling Assembly](#).

➡ **NOTICE:** When removing the microprocessor module, pull the module straight up. Be careful not to bend the pins on the microprocessor module.

4. To loosen the ZIF socket, use a small, flat-blade screwdriver and rotate the ZIF-socket cam screw counterclockwise until it comes to the cam stop.

The ZIF-socket cam screw secures the microprocessor to the system board. Take note of the arrow on the ZIF-socket cam screw.

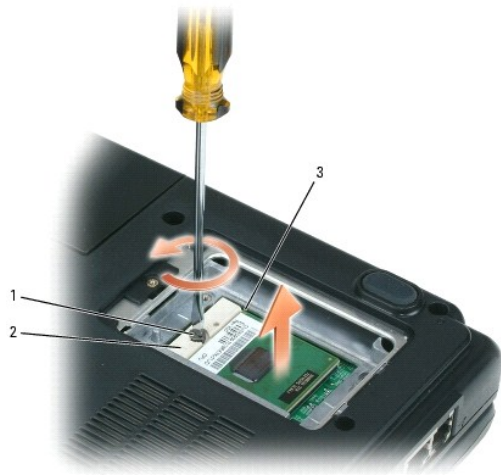

1	ZIF-socket cam screw	2	ZIF-socket	3	pin-1 corner of microprocessor
---	----------------------	---	------------	---	--------------------------------

5. Use a microprocessor extraction tool to remove the microprocessor module.

Installing the Microprocessor Module

➡ **NOTICE:** Ensure that the cam lock is in the fully open position before seating the microprocessor module. Seating the microprocessor module properly in the ZIF socket does not require force.

➡ **NOTICE:** A microprocessor module that is not properly seated can result in an intermittent connection or permanent damage to the microprocessor and ZIF socket.

1. Align the pin-1 corner of the microprocessor module so that it points to the triangle on the system board, and insert the microprocessor module into the ZIF socket.

When the microprocessor module is correctly seated, all four corners are aligned at the same height. If one or more corners of the module are higher than the others, the module is not seated correctly.

 **NOTICE:** Hold the microprocessor down while turning the cam screw to prevent intermittent contact between the cam screw and microprocessor.

2. Tighten the ZIF socket by turning the cam screw clockwise to secure the microprocessor module to the system board.
3. Wipe the thermal grease off of the microprocessor thermal-cooling assembly with a clean paper towel.
4. Replace the microprocessor thermal-cooling assembly. See [Installing the Microprocessor Thermal-Cooling Assembly](#).
5. Update the BIOS using a flash BIOS-update program CD. See [Flashing the BIOS From a CD](#).

[Back to Contents Page](#)

[Back to Contents Page](#)

Display Assembly

Dell™ Inspiron™ 1300/B120/B130 Service Manual

- [Removing the Display Assembly](#)
 - [Removing the Display Bezel](#)
 - [Removing the Display Panel](#)
 - [Installing the Display Panel](#)
-

Removing the Display Assembly

⚠ CAUTION: Before performing the following procedures, read the safety instructions in the *Product Information Guide*.

⚠ CAUTION: To prevent static damage to components inside your computer, discharge static electricity from your body before you touch any of your computer's electronic components. You can do so by touching an unpainted metal surface.

1. Follow the instructions in [Before Working Inside Your Computer](#).
2. Remove the hinge cover. See [Removing the Hinge Cover](#).
3. Remove the keyboard. See [Removing the Keyboard](#).
4. Pull straight up on the pull-tab that is attached to the display-feed flex cable to disconnect the cable from the system board.
5. Disconnect the antenna cable.
6. Close the display.
7. Turn the computer upside down with the back of the computer facing you.
8. From the bottom of the computer, remove the two M2.5 x 8-mm screws labeled "D."

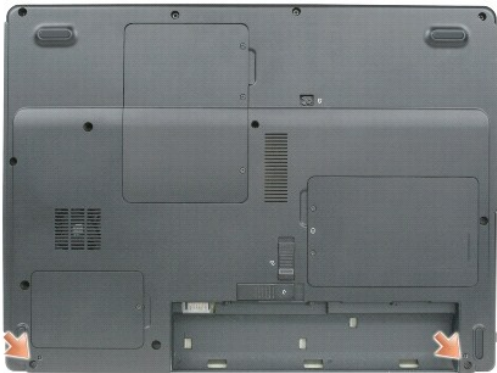

9. From the back of the computer, remove the two M2.5 x 8-mm screws labeled "D."



10. Turn the computer right-side up and open the display.
11. Carefully remove the antenna cable and the display cables from their routing guides.

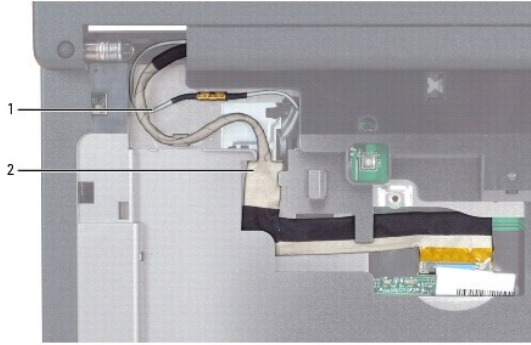

1	antenna cable	2	display cable		
---	---------------	---	---------------	--	--



1	antenna cable	2	display cable pull tab		
---	---------------	---	------------------------	--	--

➔ **NOTICE:** Be careful not to damage the display switch when removing the display.

12. Lift the display assembly out of the computer base.

Removing the Display Bezel

⚠ **CAUTION:** Before performing the following procedures, read the safety instructions in the *Product Information Guide*.

⚠ **CAUTION:** To prevent static damage to components inside your computer, discharge static electricity from your body before you touch any of your computer's electronic components. You can do so by touching an unpainted metal surface.

1. Follow the instructions in [Before Working Inside Your Computer](#).
2. Remove the display assembly. See [Removing the Display Assembly](#).
3. Use a plastic scribe to pry the six screw covers/display bumpers out of the screw holes on the front of the bezel.
4. Remove the six M2.5 x 5-mm screws from the front of the bezel.

➔ **NOTICE:** Carefully separate the bezel from the top cover to avoid damage to the bezel.

5. Starting at the bottom of the display panel, use your fingers to separate the bezel from the top cover and lift the inside edge of the bezel away from the top cover.

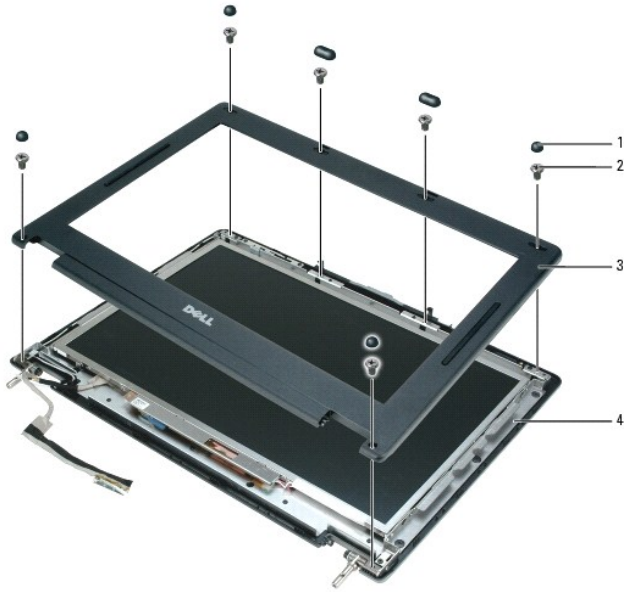

1	screw covers/display bumpers (6)	2	M2.5 x 5-mm screws (6)	3	display bezel
4	top cover				

Removing the Display Panel

CAUTION: Before performing the following procedures, read the safety instructions in the *Product Information Guide*.

CAUTION: To prevent static damage to components inside your computer, discharge static electricity from your body before you touch any of your computer's electronic components. You can do so by touching an unpainted metal surface.

1. Follow the instructions in "[Before Working Inside Your Computer](#)."
2. Remove the display assembly. See [Removing the Display Assembly](#).
3. Remove the display bezel. See [Removing the Display Bezel](#).
4. Remove the four M2 x 3-mm screws from each side of the display panel.
5. Lift the display panel out of the top cover.

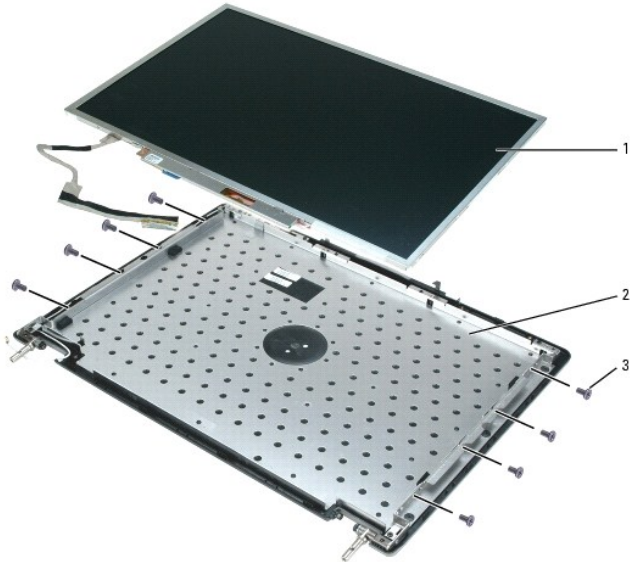

1	display panel	2	top cover	3	M2 x 3-mm screws (8)
---	---------------	---	-----------	---	----------------------

6. Press in both sides of the top flex-cable connector, and pull the top flex-cable connector away from the display connector.

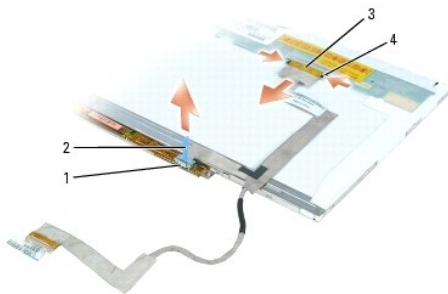

1	inverter connector	2	pull-tab on bottom flex-cable connector	3	top flex-cable connector
4	display connector				

7. Use the pull-tab to disconnect the bottom flex-cable connector from the inverter connector.

Installing the Display Panel

1. Connect the top flex-cable connector to the display panel connector.
2. Connect the bottom flex-cable connector to the inverter connector.
3. Lay the display panel into the top cover.
4. Replace the eight M2 x 3-mm screws that secure the display panel to the top cover.
5. Route the display-feed flex cable so that it rests in the notch located in the bottom edge of the top cover.
6. Replace the display bezel.

Fan

Dell™ Inspiron™ 1300/B120/B130 Service Manual

- [Removing the Cooling Fan](#)
 - [Installing the Cooling Fan](#)
-

Removing the Cooling Fan

 **CAUTION:** Before performing the following procedures, read the safety instructions in the *Product Information Guide*.

 **CAUTION:** To prevent static damage to components inside your computer, discharge static electricity from your body before you touch any of your computer's electronic components. You can do so by touching an unpainted metal surface.

1. Follow the instructions in [Before Working Inside Your Computer](#).
2. Remove the hard drive. See [Removing the Hard Drive](#).
3. Remove the optical drive. See [Removing the Optical Drive](#).
4. Remove the memory module. See [Removing the Memory Module](#).
5. Remove the Mini PCI card. See [Removing the Mini PCI Card](#).
6. Remove the microprocessor thermal-cooling assembly. See [Removing the Microprocessor Thermal-Cooling Assembly](#).
7. Remove the microprocessor. See [Removing the Microprocessor Module](#).
8. Remove the hinge cover. See [Removing the Hinge Cover](#).
9. Remove the keyboard. See [Removing the Keyboard](#).
10. Remove the display assembly. See [Removing the Display Assembly](#).
11. Remove the palm rest. See [Removing the Palm Rest](#).
12. Remove the modem. See [Removing the Modem](#).
13. Remove the speakers connector. See [Removing the Speakers](#).
14. Remove the system board. See [Removing the System Board](#).
15. Disconnect the the fan power cable from the system board.
16. Turn the system board over and remove the four M2.5 x 5-mm screws holding the metal plate in place.

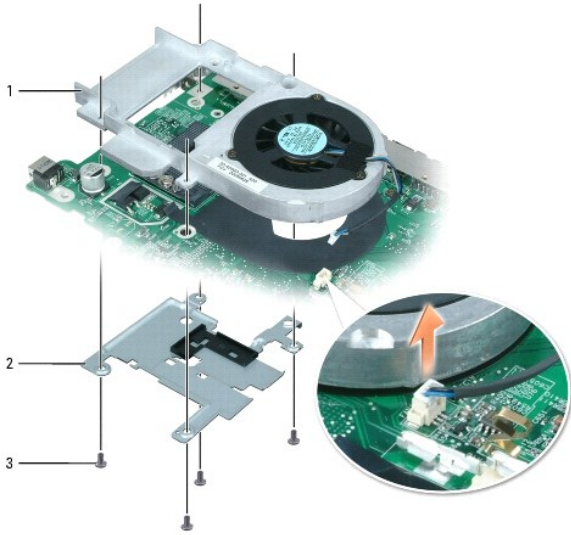

1	fan assembly	2	metal plate	3	M2.5 x 5-mm screws (4)
---	--------------	---	-------------	---	------------------------

17. Remove the plate and lift the system board off the fan assembly.

Installing the Cooling Fan

1. Position the system board over the fan assembly, aligning the screw holes in the system board with those in the fan assembly.
 2. Place the metal plate over the holes in the system board and replace the four M2.5 x 5-mm screws.
 3. Turn the system board over and connect the fan connector to the system board.
-

[Back to Contents Page](#)

Hard Drive

Dell™ Inspiron™ 1300/B120/B130 Service Manual

- [Removing the Hard Drive](#)
- [Installing the Hard Drive](#)

Removing the Hard Drive

- ⚠ **CAUTION:** If you remove the hard drive from the computer when the drive is hot, *do not touch* the metal housing of the hard drive.
- ⚠ **CAUTION:** Before you begin any of the procedures in this section, follow the safety instructions in the *Product Information Guide*.
- 🔒 **NOTICE:** To prevent data loss, turn off your computer before removing the hard drive. Do not remove the hard drive while the computer is on, in standby mode, or in hibernate mode.
- 🔒 **NOTICE:** Hard drives are extremely fragile; even a slight bump can damage the drive.
- 📄 **NOTE:** Dell does not guarantee compatibility or provide support for hard drives from sources other than Dell.
- 📄 **NOTE:** If you are installing a hard drive from a source other than Dell, you need to install an operating system, drivers, and utilities on the new hard drive.

To replace the hard drive in the hard drive bay:

1. Follow the instructions in [Before Working Inside Your Computer](#).
2. Turn the computer over, and loosen the two captive screws in the hard drive cover.



	1	captive screws (2)		
--	---	--------------------	--	--

- 🔒 **NOTICE:** When the hard drive is not in the computer, store it in protective antistatic packaging. See "Protecting Against Electrostatic Discharge" in the *Product Information Guide*.

3. Lift the cover off the computer and set it aside.
4. Slide the hard drive carrier away from the screw holes, and then use the tab to lift the hard drive straight up to remove it from the computer.

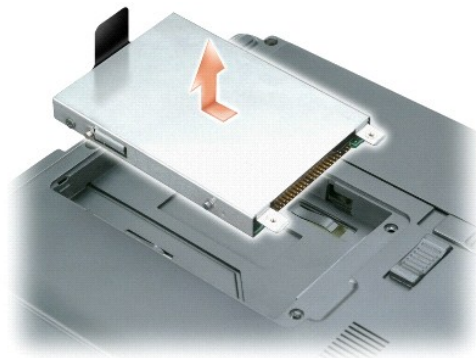

Installing the Hard Drive

1. Remove the new drive from its packaging.

Save the original packaging for storing or shipping the hard drive.

 **NOTICE:** Use firm and even pressure to slide the drive into place. If you use excessive force, you may damage the connector.

2. Seat the new hard drive into the bay, and then slide it into the connector by sliding it toward the screw holes until it is fully seated.
3. Replace the cover and tighten the screws.
4. Install the operating system for your computer, using the *Operating System* CD.
5. Install the drivers and utilities for your computer.

Returning a Hard Drive to Dell

Return your old hard drive to Dell in its original or comparable foam packaging. Otherwise, the hard drive may be damaged in transit.

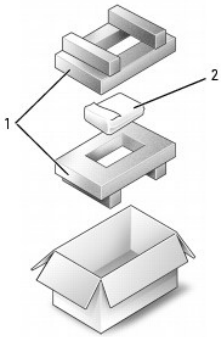

1	foam packaging	2	hard drive		
---	----------------	---	------------	--	--

[Back to Contents Page](#)

Hinge

Dell™ Inspiron™ 1300/B120/B130 Service Manual

- [Removing the Hinge Cover](#)
- [Replacing the Hinge Cover](#)

CAUTION: Before performing the following procedures, read the safety instructions in the *Product Information Guide*.

CAUTION: To prevent static damage to components inside your computer, discharge static electricity from your body before you touch any of your computer's electronic components. You can do so by touching an unpainted metal surface.

NOTICE: The hinge cover is fragile and can be damaged if extreme force is used. Be careful when removing the hinge cover.

Removing the Hinge Cover

1. Follow the instructions in [Before Working Inside Your Computer](#).
2. Turn the computer right-side up, and then open the display all the way (180 degrees) so that it rests on your work surface.

NOTICE: To avoid damaging the hinge cover, do not lift the cover on both sides simultaneously.

3. Insert a scribe in the indent to lift the hinge cover on the right side.



1	hinge cover	2	indent		
---	-------------	---	--------	--	--

4. Ease the hinge cover up, moving from right to left, and remove it.
-

Replacing the Hinge Cover

1. Insert the left edge of the cover into place.
 2. Press from left to right until the cover snaps into place.
 3. Close the display and turn the computer upside-down.
 4. Replace the battery. See [Replacing the Battery](#).
-

Keyboard

Dell™ Inspiron™ 1300/B120/B130 Service Manual

- [Removing the Keyboard](#)
- [Replacing the Keyboard](#)

Removing the Keyboard

- ⚠ **CAUTION:** Before working inside your Dell™ computer, read the safety instructions in your *Product Information Guide*.
- ⚠ **CAUTION:** To prevent static damage to components inside your computer, discharge static electricity from your body before you touch any of your computer's electronic components. You can do so by touching an unpainted metal surface.

1. Follow the instructions in [Before Working Inside Your Computer](#).
2. Remove the hinge cover. See [Removing the Hinge Cover](#).
3. Remove the two screws at the top of the keyboard.

➡ **NOTICE:** The keycaps on the keyboard are fragile, easily dislodged, and time-consuming to replace. Be careful when removing and handling the keyboard.

4. Lift up the keyboard, and hold it up and slightly forward to allow access to the keyboard connector on the system board.
5. Lift the keyboard connector and slide out the keyboard cable.

Replacing the Keyboard

➡ **NOTICE:** To avoid scratching the palm rest when replacing the keyboard, hook the tabs along the front edge of the keyboard into the palm rest, and then secure the keyboard in place.

1. To replace the keyboard, connect the keyboard connector to the system board.
2. Place the tabs along the front edge of the keyboard into the palm rest and lay the keyboard down on the palmrest.
3. Replace the two screws at the top of the keyboard.
4. Replace the hinge cover. See [Replacing the Hinge Cover](#).



1	keyboard	2	system board connector		
---	----------	---	------------------------	--	--

[Back to Contents Page](#)

Modem

Dell™ Inspiron™ 1300/B120/B130 Service Manual

- [Removing the Modem](#)
- [Replacing the Modem](#)

Removing the Modem

- ⚠ **CAUTION:** Before you begin the following procedure, see the safety instructions in the *Product Information Guide*.
- 🔧 **NOTICE:** To avoid damaging the system board, you must remove the main battery before you begin working inside the computer. See [Replacing the Battery](#).
- ⚠ **CAUTION:** To prevent static damage to components inside your computer, discharge static electricity from your body before you touch any of your computer's electronic components. You can do so by touching an unpainted metal surface.

1. Follow the instructions in [Before Working Inside Your Computer](#).
2. Remove the hinge cover. See [Removing the Hinge Cover](#).
3. Remove the optical drive. See [Removing the Optical Drive](#).
4. Remove the keyboard. See [Removing the Keyboard](#).
5. Remove the coin-cell battery. See [Removing the Coin-Cell Battery](#).
6. Remove the display assembly. See [Removing the Display Assembly](#).
7. Remove the palm rest. See [Removing the Palm Rest](#).
8. Remove the two M2 x 3-mm screws that attach the modem to the system board.
9. Pull up on the pull-tab to disconnect the modem from the connector on the system board.

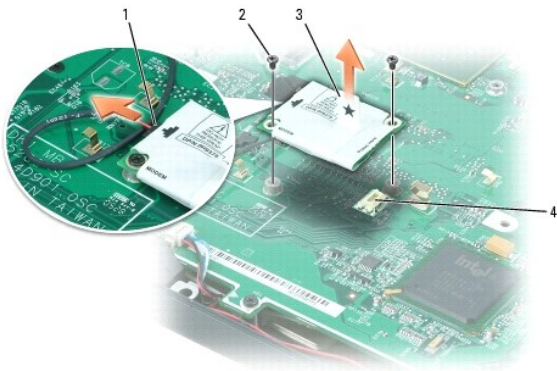

1	modem cable	2	M2 x 3-mm screws (2)	3	modem pull-tab
4	system board connector				

- 🔧 **NOTICE:** Do not disconnect the modem cable from the system board.

10. Disconnect the modem cable from the modem.

Replacing the Modem

1. Connect the modem cable to the modem.

 **NOTICE:** Ensure that the modem cable is routed correctly when you replace the modem.

2. Connect the modem to the system board.

Align the connector on the bottom of the modem with the modem connector on the system board, and press down on the right side of the modem.

3. Replace the two M2 x 3-mm screws.

[Back to Contents Page](#)

Palm Rest

Dell™ Inspiron™ 1300/B120/B130 Service Manual

• [Removing the Palm Rest](#)

Removing the Palm Rest

⚠ CAUTION: Before performing the following procedures, read the safety instructions in the *Product Information Guide*.

⚠ CAUTION: To prevent static damage to components inside your computer, discharge static electricity from your body before you touch any of your computer's electronic components. You can do so by touching an unpainted metal surface.

1. Follow the instructions in [Before Working Inside Your Computer](#).
2. Remove the hinge cover. See [Removing the Hinge Cover](#).
3. Remove the optical drive. See [Removing the Optical Drive](#).
4. Remove the keyboard. See [Removing the Keyboard](#).
5. Remove the coin-cell battery. See [Removing the Coin-Cell Battery](#).
6. Remove the display assembly. See [Removing the Display Assembly](#).
7. Turn the computer upside down and remove the ten M2.5 x 8-mm screws from the bottom of the computer.

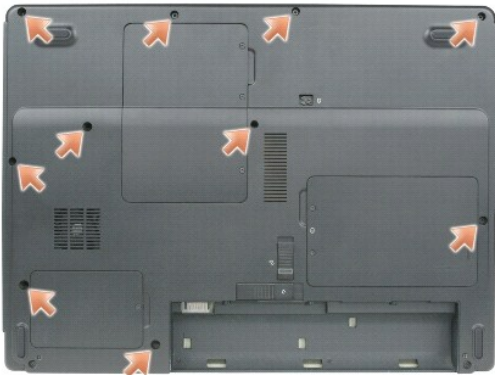

8. Turn the computer top-side up and remove the five M2.5 x 5-mm screws from the top of the palm rest and the remaining two M2.5 x 3-mm screws from near the power button and the activity LEDs.

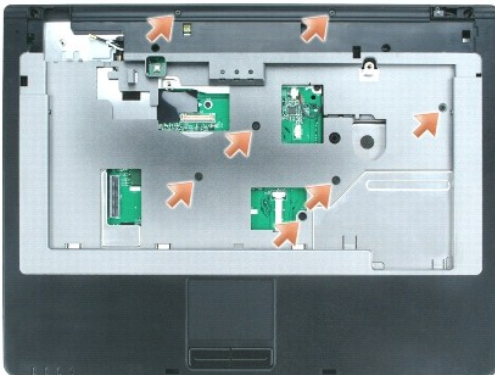

9. Disconnect the touch pad connector from the system board by pulling the release tabs forward away from the connector and removing the cable.



1	suspend switch connector	2	touch pad ribbon cable release tabs (2)	3	touch pad ribbon cable
---	--------------------------	---	---	---	------------------------

10. Disconnect the suspend switch connector from the system board.

➔ **NOTICE:** Carefully separate the palm rest from the base plastics to avoid damage to the palm rest.

11. Starting at the back center of the palm rest, use your fingers to separate the palm rest from the base plastics by lifting the inside edge of the palm rest.

[Back to Contents Page](#)

Pinout Assignments for I/O Connectors

Dell™ Inspiron™ 1300/B120/B130 Service Manual

- [USB Connector](#)
- [Video Connector](#)

USB Connector

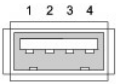

Pin	Signal
1	USB5V+
2	USBP-
3	USBP+
4	GND

Video Connector

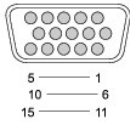

Pin	Signal	Pin	Signal
1	CRT_R	9	5V+
2	CRT_G	10	GND
3	CRT_B	11	MONITOR_DETECT-
4	NC	12	DDC_DATA
5	GND	13	CRT_HS
6	GND	14	CRT_VS
7	GND	15	DDC_CLK
8	GND		

Speakers

Dell™ Inspiron™ 1300/B120/B130 Service Manual

- [Removing the Speakers](#)
- [Installing the Speakers](#)

Removing the Speakers

⚠ CAUTION: Before performing the following procedures, read the safety instructions in the *Product Information Guide*.

⚠ CAUTION: To prevent static damage to components inside your computer, discharge static electricity from your body before you touch any of your computer's electronic components. You can do so by touching an unpainted metal surface.

The speakers are located on the left and right front corners of the base plastics. Take note of the speaker cable routing so that you can replace the cables properly under or between their routing clips.

1. Follow the instructions in [Before Working Inside Your Computer](#).
2. Remove the hinge cover. See [Removing the Hinge Cover](#).
3. Remove the optical drive. See [Removing the Optical Drive](#).
4. Remove the keyboard. See [Removing the Keyboard](#).
5. Remove the coin-cell battery. See [Removing the Coin-Cell Battery](#).
6. Remove the palm rest. See [Removing the Palm Rest](#).
7. Disconnect the speaker connector from the system board.

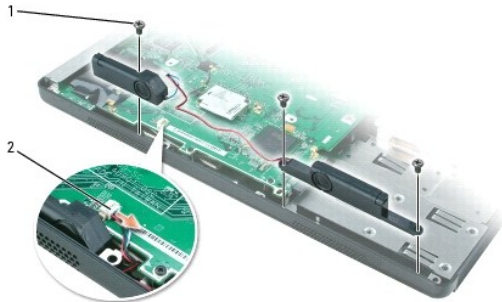

1	M2.5 x 3-mm screws (3)	2	speaker connector		
---	------------------------	---	-------------------	--	--

➡ NOTICE: Remove the speaker cables from their routing clips with care to avoid damaging the cables.

8. Remove the speaker cables from under or between their routing clips.

➡ NOTICE: Handle the speakers with care to avoid damaging them.

9. Remove the three M2 x 3-mm screws from the speaker mounts.
10. Remove the speakers by pulling them straight up and out of the base plastics.

Installing the Speakers

1. Slide the speakers down into the base plastics.

 **NOTICE:** Ensure that the speaker cables are under or between their routing clips.

 **NOTE:** The speakers face out in the base plastics holders.

 **NOTE:** The right speaker cable is longer than the left speaker cable.

2. Route the speaker cables under or between their routing clips.
3. Replace the three M2 x 3-mm screws.
4. Connect the speaker connector to the system board.

[Back to Contents Page](#)

System Board

Dell™ Inspiron™ 1300/B120/B130 Service Manual

- [Removing the System Board](#)
- [Installing the System Board](#)

Removing the System Board

⚠ CAUTION: Before performing the following procedures, read the safety instructions in the *Product Information Guide*.



⚠ CAUTION: To prevent static damage to components inside your computer, discharge static electricity from your body before you touch any of your computer's electronic components. You can do so by touching an unpainted metal surface.

The system board's BIOS chip contains the Service Tag, which is also visible on a barcode label on the bottom of the computer. The replacement kit for the system board includes a CD that provides a utility for transferring the Service Tag to the replacement system board.

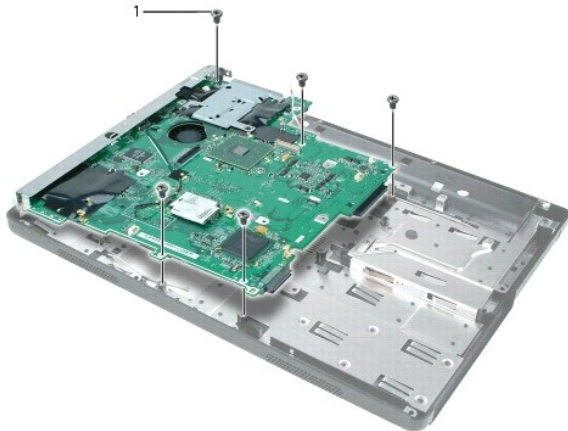
1. Follow the instructions in [Before Working Inside Your Computer](#).
2. Remove the hard drive. See [Removing the Hard Drive](#).
3. Remove the optical drive. See [Removing the Optical Drive](#).
4. Remove the memory module. See [Removing the Memory Module](#).
5. Remove the Mini PCI card. See [Removing the Mini PCI Card](#).
6. Remove the microprocessor thermal-cooling assembly. See [Removing the Microprocessor Thermal-Cooling Assembly](#).
7. Remove the microprocessor. See [Removing the Microprocessor Module](#).
8. Remove the hinge cover. See [Removing the Hinge Cover](#).
9. Remove the keyboard. See [Removing the Keyboard](#).
10. Remove the display assembly. See [Removing the Display Assembly](#).
11. Remove the palm rest. See [Removing the Palm Rest](#).
12. Remove the modem. See [Removing the Modem](#).
13. Remove the speakers connector. See [Removing the Speakers](#).
14. Remove the five M2.5 x 5-mm system board screws and lift the system board out and away from the base plastics.



Installing the System Board

1. Insert the video connector on the replacement system board through the side of the base plastics.
 2. Replace the five M2.5 x 5-mm screws that secure the system board to the base plastics.
 3. Reconnect the speakers. See [Installing the Speakers](#).
 4. Replace the modem removed from the system board. See [Replacing the Modem](#).
 5. Replace the palm rest. See [Removing the Palm Rest](#) and follow the procedure in reverse order.
 6. Replace the display assembly. See [Removing the Display Assembly](#) and follow the procedure in reverse order.
 7. Replace the keyboard. See [Replacing the Keyboard](#).
 8. Replace the microprocessor. See [Installing the Microprocessor Module](#).
-  **NOTICE:** Before you replace the microprocessor thermal-cooling assembly, wipe the thermal grease off of the assembly with a clean paper towel. Squeeze the contents of the thermal grease packet (provided with the kit) onto the microprocessor thermal-cooling assembly.
9. Replace the microprocessor thermal-cooling assembly. See [Installing the Microprocessor Thermal-Cooling Assembly](#).
 10. Replace the Mini PCI card that you removed from the old system board. See [Installing the Mini PCI Card](#).
 11. Replace the memory module that you removed from the old system board. See [Replacing the Memory Module](#).
 12. Replace the optical drive. See [Installing the Optical Drive](#).
 13. Replace the hard drive. See [Installing the Hard Drive](#).
 14. Insert the battery into the battery bay. See [Replacing the Battery](#).
 15. Connect the AC adapter to the computer and to an electrical outlet.
-  **NOTICE:** Before turning on the computer, replace all screws and ensure that no stray screws remain inside the computer. Failure to do so may result in damage to the computer.
-  **NOTE:** After replacing the system board, enter the computer Service Tag into the BIOS of the replacement system board.
16. Turn on the computer.
 17. Insert the CD that accompanied the replacement system board into the appropriate drive. Follow the instructions on the screen.
-

System Components

Dell™ Inspiron™ 1300/B120/B130 Service Manual

CAUTION: Only a certified service technician should perform repairs on your computer. Damage due to servicing that is not authorized by Dell is not covered by your warranty.

NOTICE: Unless otherwise noted, each procedure in this document assumes that a part can be replaced by performing the removal procedure in reverse order.

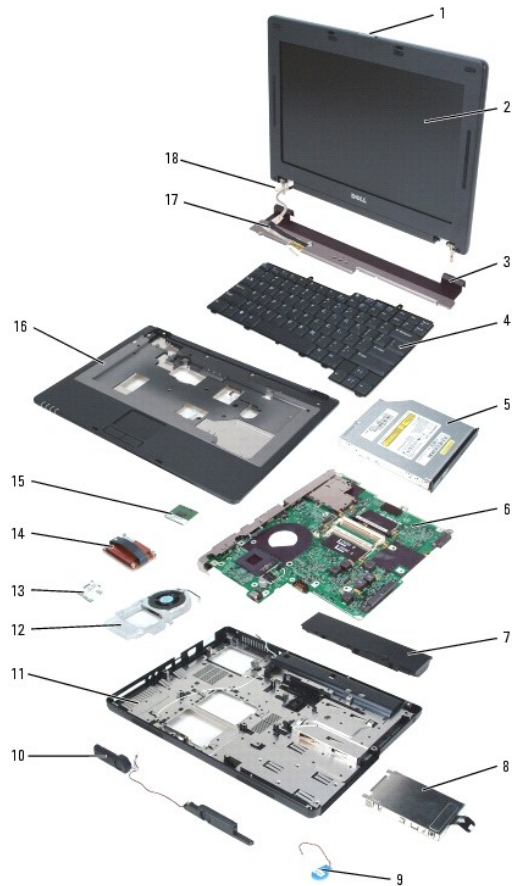

1	display latch
2	display
3	hinge cover
4	keyboard
5	optical drive
6	system board
7	battery
8	hard drive
9	coin-cell battery
10	speakers (2)
11	base plastics
12	fan assembly
13	modem
14	microprocessor cooling assembly
15	microprocessor
16	palm rest
17	display-feed flex cable

[Back to Contents Page](#)

Microprocessor Thermal-Cooling Assembly

Dell™ Inspiron™ 1300/B120/B130 Service Manual

- [Removing the Microprocessor Thermal-Cooling Assembly](#)
- [Installing the Microprocessor Thermal-Cooling Assembly](#)

Removing the Microprocessor Thermal-Cooling Assembly

- ⚠ **CAUTION:** Before performing the following procedures, read the safety instructions in the *Product Information Guide*.
- ⚠ **CAUTION:** To prevent static damage to components inside your computer, discharge static electricity from your body before you touch any of your computer's electronic components. You can do so by touching an unpainted metal surface.

1. Follow the instructions in [Before Working Inside Your Computer](#).
2. Turn over the computer.
3. Loosen the captive screw in the thermal-cooling/microprocessor cover and remove the cover.



4. Loosen in consecutive order the four captive screws, labeled "1" through "4," in the thermal-cooling assembly.
5. Lift the thermal-cooling assembly out of the computer by pulling straight up on the pull-strap.



1	thermal-cooling assembly pull-strap	2	captive screws (4)		
---	-------------------------------------	---	--------------------	--	--

Installing the Microprocessor Thermal-Cooling Assembly

 **NOTICE:** Before you install the replacement microprocessor thermal-cooling assembly, remove the mylar that covers the thermal grease on the assembly.

1. Lower the microprocessor thermal-cooling assembly into place on top of the microprocessor, aligning the numbered screws, labeled "1" through "4," with the numbers on the fan assembly, and the arrow on the pull-strap pointing toward the outside edge of the system board.
2. Tighten the four captive screws, labeled "1" through "4," in consecutive order.
3. Replace the thermal-cooling/microprocessor cover and tighten the screws.

[Back to Contents Page](#)

[Back to Contents Page](#)

Dell™ Inspiron™ 1300/B120/B130 Service Manual



NOTE: A NOTE indicates important information that helps you make better use of your computer.



NOTICE: A NOTICE indicates either potential damage to hardware or loss of data and tells you how to avoid the problem.



CAUTION: A CAUTION indicates a potential for property damage, personal injury, or death.

Information in this document is subject to change without notice.
© 2005 Dell Inc. All rights reserved.

Reproduction in any manner whatsoever without the written permission of Dell Inc. is strictly forbidden.

Trademarks used in this text: *Dell*, the *DELL* logo, and *Inspiron* are trademarks of Dell Inc.

Other trademarks and trade names may be used in this document to refer to either the entities claiming the marks and names or their products. Dell Inc. disclaims any proprietary interest in trademarks and trade names other than its own.

[Back to Contents Page](#)

Memory, Optical Drive, and Mini PCI Card

Dell™ Inspiron™ 1300/B120/B130 Service Manual

- [Memory](#)
- [Optical Drive](#)
- [Mini PCI Card](#)

Memory

Removing the Memory Module

- ⚠ **CAUTION:** Before working inside your Dell™ computer, read the safety instructions in the *Product Information Guide*.
- ⚠ **CAUTION:** To prevent static damage to components inside your computer, discharge static electricity from your body before you touch any of your computer's electronic components. You can do so by touching an unpainted metal surface.
- 📌 **NOTE:** Memory modules purchased from Dell are covered under your computer warranty.

1. Follow the instructions in [Before Working Inside Your Computer](#).
2. Ground yourself by touching one of the metal connectors on the back of the computer.

📌 **NOTE:** If you leave the area, ground yourself again when you return to the computer.

3. Turn the computer over, loosen the captive screws on the memory module/Mini PCI cover, and then remove the cover.



	1	captive screws (3)		
--	---	--------------------	--	--

🔁 **NOTICE:** To prevent damage to the memory module connector, do not use tools to spread the memory-module securing clips.

4. If you are replacing a memory module, remove the existing module:
 - a. Use your fingertips to carefully spread apart the securing clips on each end of the memory module connector until the module pops up.
 - b. Remove the module from the connector.

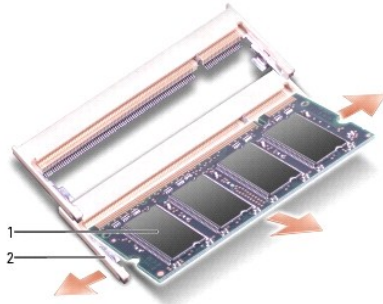

1	memory module	2	securing clips (2 per connector)		
---	---------------	---	----------------------------------	--	--

Replacing the Memory Module

1. Ground yourself and install the new memory module:
 - a. Align the notch in the module edge connector with the tab in the connector slot.
 - b. Slide the module firmly into the slot at a 45-degree angle, and rotate the module down until it clicks into place. If you do not feel the click, remove the module and reinstall it.

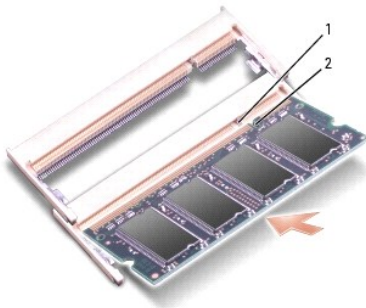

1	memory slot notch	2	memory slot tab		
---	-------------------	---	-----------------	--	--

2. Replace the memory module/Mini PCI cover and tighten the screws.

NOTICE: If the cover is difficult to close, remove the module and reinstall it. Forcing the cover to close may damage your computer.

3. Insert the battery into the battery bay, or connect the AC adapter to your computer and an electrical outlet.
4. Turn on the computer.

As the computer boots, it detects the additional memory and automatically updates the system configuration information.

To confirm the amount of memory installed in the computer, click the **Start** button, click **Help and Support**, and then click **Computer Information**.

Optical Drive

Removing the Optical Drive

CAUTION: Before working inside your Dell™ computer, read the safety instructions in the *Product Information Guide*.

NOTICE: To prevent damage to devices, store them in a safe, dry place when they are not installed in the computer. Avoid pressing down on them or placing heavy objects on top of them.

NOTE: If your computer shipped with a device security screw and the screw is not installed, you can remove and install devices while the computer is running and connected to a docking device.

1. If you want to remove the optical drive while the computer is turned on, double-click the **Safely Remove Hardware** icon on the taskbar, click the device that you want to eject, and click **Stop**. Otherwise go to step 2.
2. Close your display and turn the computer upside down.
3. Use a Phillips screwdriver to remove the M2.5 x 8-mm screw from the indentation labeled with a lock symbol ().
4. Using a screwdriver or some other type of probe, push the notch where the device security screw was removed toward the outside of the computer.
5. Pull the device straight out of the media bay.

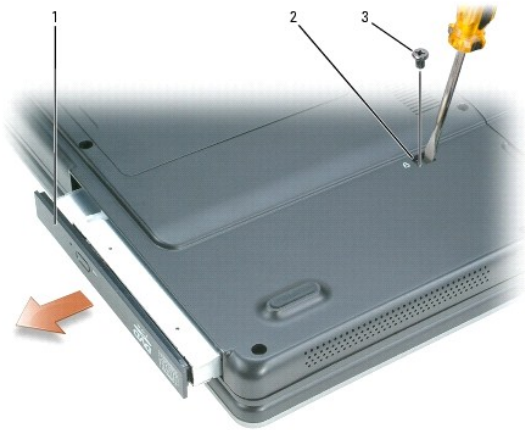

1	CD/DVD drive	2	drive removal slot	3	M2.5 x 8-mm screw labeled "  "
---	--------------	---	--------------------	---	--

Installing the Optical Drive

1. Slide the new drive into the bay until it snaps securely into place.
2. Replace the M2.5 x 8-mm screw.
3. Turn the computer right-side up and open the display.
4. The operating system automatically recognizes the device. If necessary, enter your password to unlock your computer.

Mini PCI Card

Removing the Mini PCI Card

If you ordered a Mini PCI card with your computer, the card is already installed.

 **CAUTION:** Before you begin any of the procedures in this section, follow the safety instructions in the *Product Information Guide*.

 **NOTICE:** To avoid damaging the system board, you must remove the main battery before you begin working inside the computer.

1. Follow the instructions in [Before Working Inside Your Computer](#).
2. Turn the computer over, loosen the captive screws on the memory module/Mini PCI cover, and then remove the cover.



	1	captive screws (3)		
--	---	--------------------	--	--

3. If a Mini PCI card is not already installed, go to [step 1](#). If you are replacing a Mini PCI card, remove the existing card:
- Disconnect the antenna cable from the Mini PCI card.



	1	antenna cable		
--	---	---------------	--	--

- Release the Mini PCI card by spreading the metal securing tabs until the card pops up slightly.
- Lift the Mini PCI card out of its connector.

➡ **NOTICE:** The connectors are keyed to ensure correct insertion. If you feel resistance, check the connectors and realign the card.



1	Mini PCI card	2	metal securing tabs (2)		
---	---------------	---	-------------------------	--	--

Installing the Mini PCI Card

1. Install the replacement Mini PCI card:

➔ **NOTICE:** To avoid damaging the Mini PCI card, make sure the antenna cable is not under the card when you press the card into place.

- a. Align the Mini PCI card with the connector at a 45-degree angle, and press the Mini PCI card into the connector until it clicks.



1	Mini PCI card	2	metal securing tabs (2)		
---	---------------	---	-------------------------	--	--

- b. Connect the antenna cable to the Mini PCI card. Make sure the cable snaps onto the primary connector on the Mini PCI card.



		1	antenna cable		
--	--	---	---------------	--	--

2. Replace the memory module/Mini PCI cover and tighten the screws.

➔ **NOTICE:** If the cover is difficult to close, remove the module and reinstall it. Forcing the cover to close may damage your computer.

3. Insert the battery into the battery bay, or connect the AC adapter to your computer and an electrical outlet.
4. Turn on the computer.